

Bain Signature

7300 Rue Sherbrooke O,
Montréal, QC H4B 1R7
www.bainsignature.com

Model Modèle: **VIVIAN-PNT**

Artistic Freestanding bathtub
Baignoire autoportante artistique

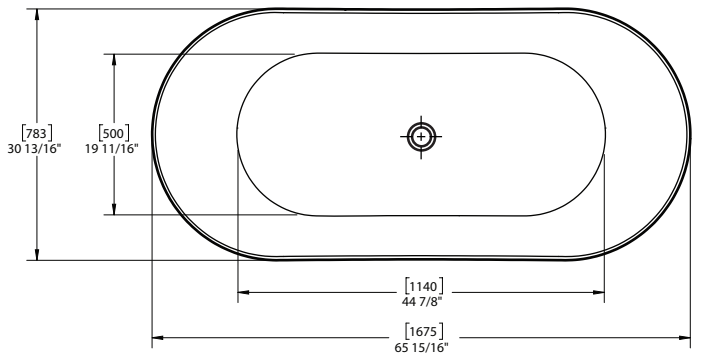
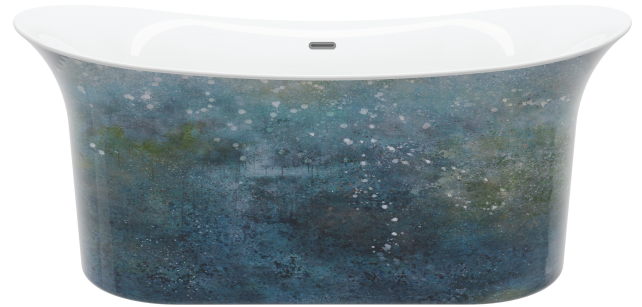

TOP VIEW VUE DE DESSUS

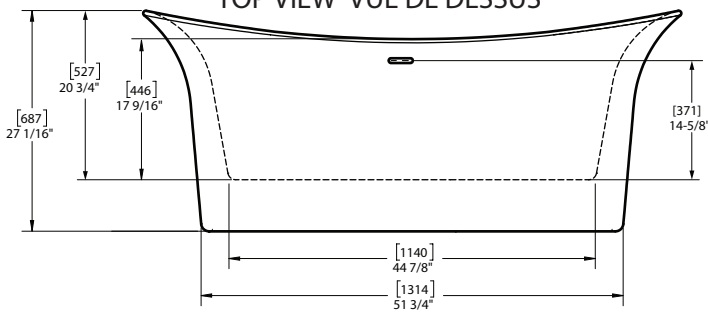

FRONT VIEW VUE DE FACE

* Dimensions may vary +/- 1/4" (6mm) / Les dimensions peuvent varier de +/- 1/4" (6mm)

gallons to overflow / gallon au trop plein	55 gal.
packaging dimension d'emballage	70 x 33 x 30 in
approximated weight / Poids approximatif	120 lbs
weight with water / poids rempli d'eau	579.25 lbs
bathing well at sump / dimension interieur au rebord	45 x 20 in

Compliance Certifications:

Uniform Plumbing Code
National Plumbing Code of Canada
CSA B45.5-17/IAPMO Z124-2017



Pure acrylic construction reinforced by fiberglass
Construction en acrylique renforcée de fibre de verre

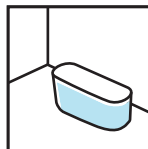

Freestanding installation
Installation autoportante

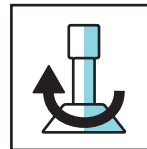

Adjustable feet
Pattes ajustables

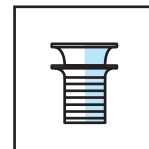

Chrome drain included
Drain chrome inclu

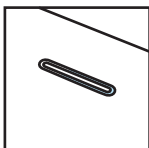

Integrated chrome linear overflow
Trop plein linéaire chrome intégré



CUPC certified
Certifié CUPC